

:

-:

.

-

:

()

-

()

-

:

..



*

*

*

*

1-

()

(1-)

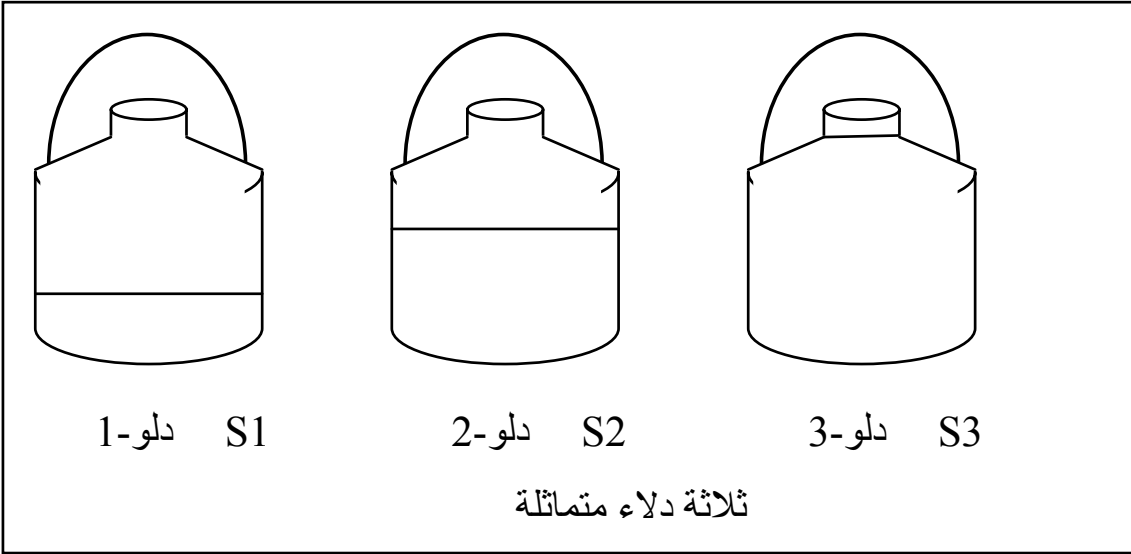

الوثيقة-1

T

(s)



$P_{T/S3}$



:
:
- _____

() .(2-

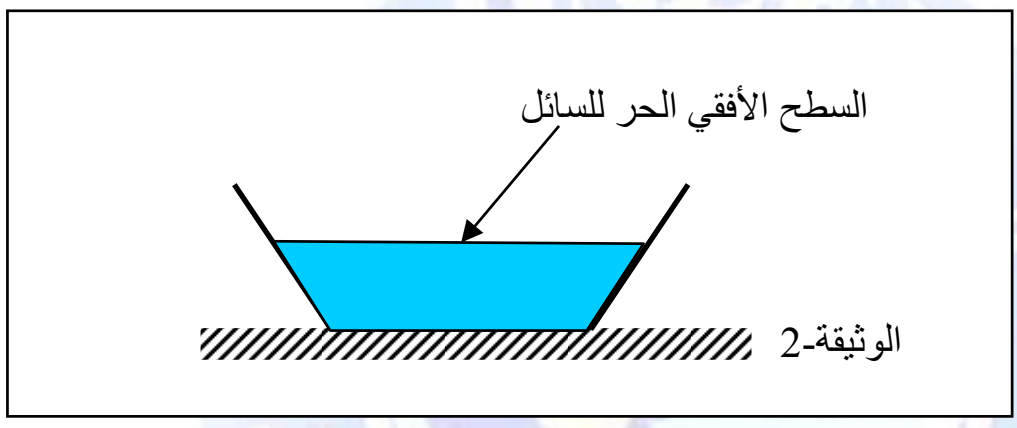

:
:
:
:2-

(3-

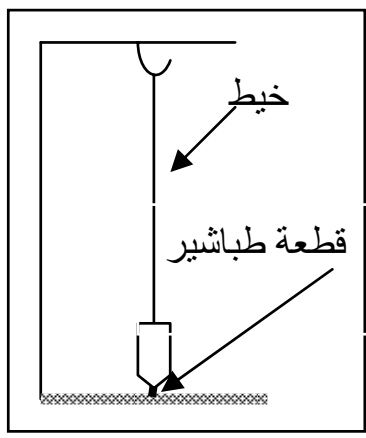

الوثيقة-3

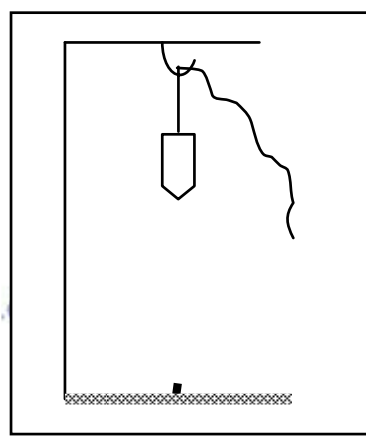

الوثيقة-4 أ

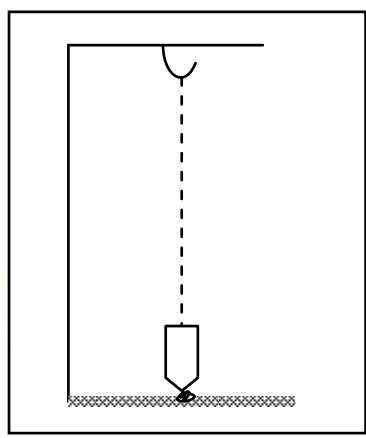

الوثيقة-4 ب

(-4) .

-4 .

() .

_____ :

_____ :

1-

(-5) .

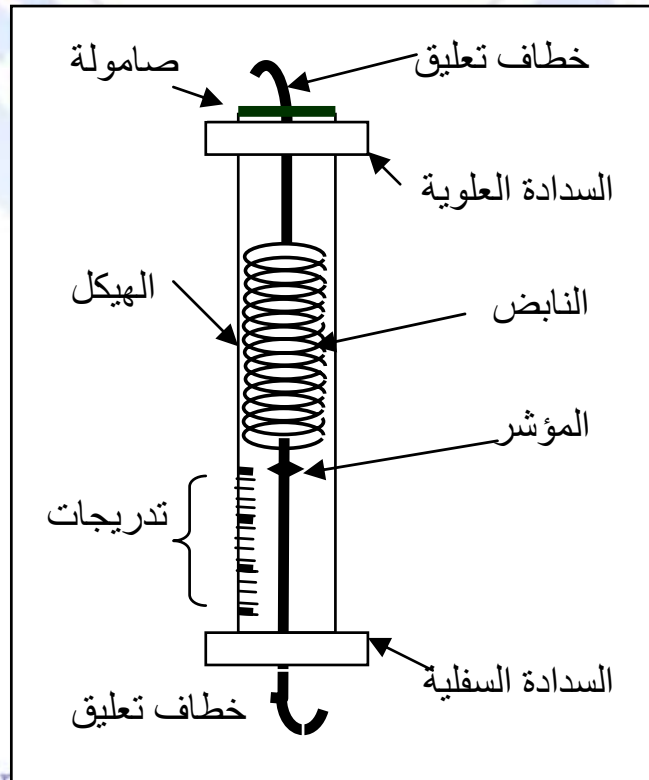

الوثيقة -5



:

*

*

-

-

-

*

$P_{T/S}$

*N

*



_____ :

.....

.....

.....

.....

:

6

-1

(1cm 2N)

-2

_____ :

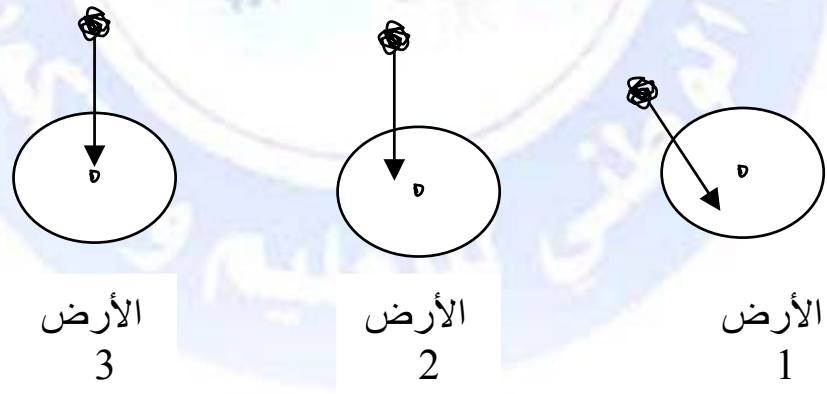

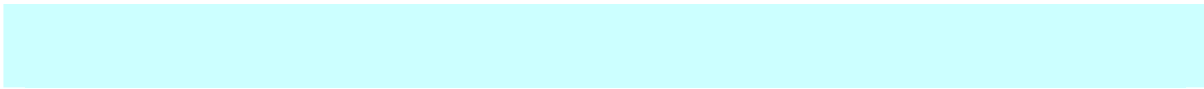

_____ :

_____ :

.N

_____ :

_____ :

(6N)

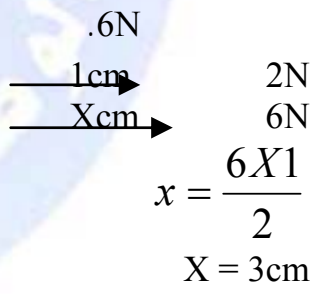
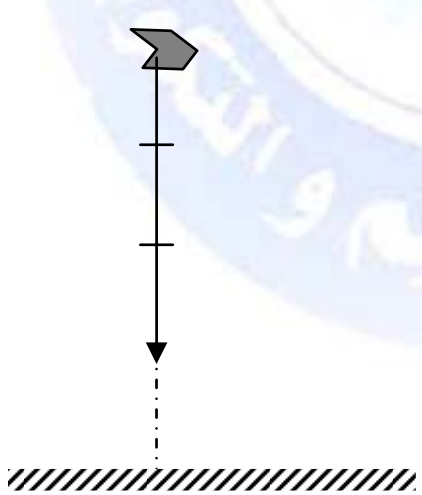

الأرض

(1)

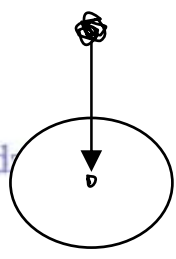

الأرض

